

Technical data sheet

Product features



Display unit heated, bain marie tub GN 3-1/1 drop-in

Model	SAP Code	00012092
--------------	-----------------	----------



- Buffet type: RED - heated, Bain Marie
- Device properties: Warmed
- Number of GN / EN: 3
- GN / EN size in device: GN 1/1
- GN device depth: 200
- Minimum device temperature [°C]: 60
- Maximum device temperature [°C]: 90

SAP Code	00012092	Loading	230 V / 1N - 50 Hz
Net Width [mm]	650	Number of GN / EN	3
Net Depth [mm]	1139	GN / EN size in device	GN 1/1
Net Height [mm]	290	GN device depth	200
Net Weight [kg]	31.00	Minimum device temperature [°C]	60
Power electric [kW]	1.500	Maximum device temperature [°C]	90

Technical data sheet

Technical drawing



Display unit heated, bain marie tub GN 3-1/1 drop-in

Model

SAP Code

00012092

A= ELECTRICAL CONNECTION
 D= WATER DISCHARGE G1/2" (M) ONLY BM
 E= WATER INLET G3/4" (M) ONLY BM

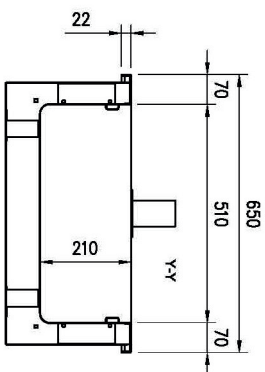
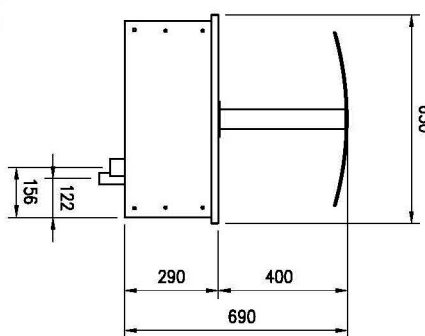
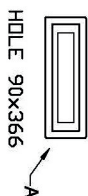
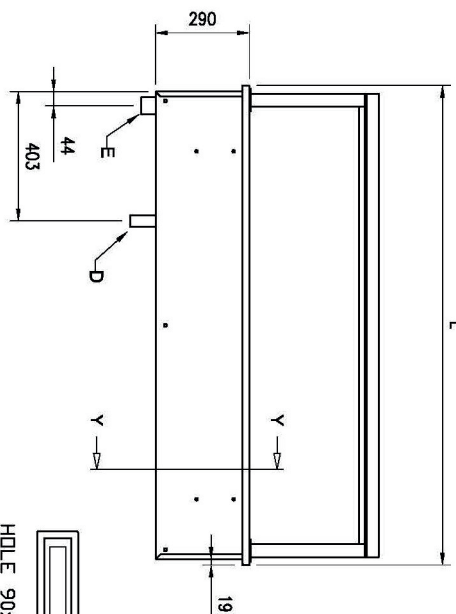
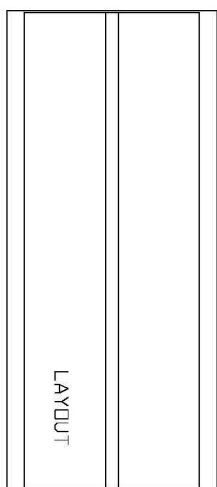

GN	L	HOLE
2/1	844	814x620
3/1	1169	1139x620
4/1	1494	1464x620
5/1	1819	1789x620
6/1	2144	2114x620

FLAT

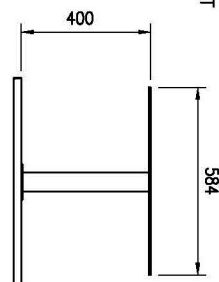

SERVICE

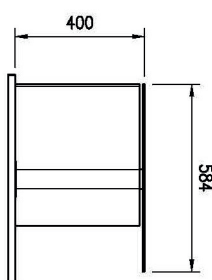

TRADITION

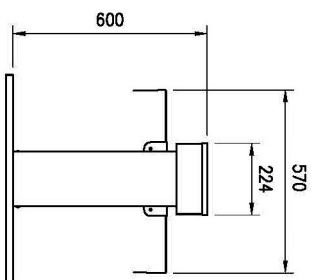

Technical data sheet

Product benefits



Display unit heated, bain marie tub GN 3-1/1 drop-in

Model

SAP Code

00012092

1

Built-in

the possibility to plant in a dispensing block design

- unified design of the dispensing line
- a luxurious look that customers appreciate

2

One large bathtub

one controller for the whole bain
one controller for the whole bain

- very easy to use
- easy maintenance

3

GN insertion up to 200mm

variability of use

- possibility of heating different types of food and larger volumes
- saving time, space, costs

4

Rounded corners

basins without sharp edges and corners

- higher hygienic safety
- time saving due to easy cleaning

5

All-stainless steel construction

basins without sharp edges and corners

- long service life
- very easy to clean

Technical data sheet

Technical parameters



Display unit heated, bain marie tub GN 3-1/1 drop-in

Model

SAP Code

00012092

1. SAP Code:

00012092

2. Net Width [mm]:

650

3. Net Depth [mm]:

1139

4. Net Height [mm]:

290

5. Net Weight [kg]:

31.00

6. Gross Width [mm]:

730

7. Gross depth [mm]:

1230

8. Gross Height [mm]:

700

9. Gross Weight [kg]:

37.00

10. Device type:

Electric unit

11. Material:

AISI 304

12. Buffet type:

RED - heated, Bain Marie

13. Device properties:

Warmed

14. Exterior color of the device:

Stainless steel

15. Power electric [kW]:

1.500

16. Loading:

230 V / 1N - 50 Hz

17. Number of GN / EN:

3

18. GN / EN size in device:

GN 1/1

19. GN device depth:

200

20. Minimum device temperature [°C]:

60

21. Maximum device temperature [°C]:

90

22. Filling:

Automatic